



Owner's Manual

NanaWall HSW60

Thermally Broken Aluminum Framed Single Track Sliding System

This Owner's Manual contains instructions on the installation, operation, maintenance and warranty of the NanaWall HSW60 Thermally Broken Aluminum Framed Single Track Sliding System. This manual is to be used by the installer for installation and is to be kept by the Owner for reference. Replacement parts can be ordered directly through NanaWall Systems.

Installation Instructions

The installation of the HSW60 System requires a working knowledge and experience in the use of tools, equipment and methods necessary for the installation of aluminum doors, windows, storefronts, and/or partitions. This practice assumes a familiarity with preparing a proper and structurally sound opening, proper structural support for stacking bays, proper anchorage, waterproofing, caulking, and sealing and assumes an understanding of the fundamentals of building construction that affect the installation of large horizontal single track sliding systems. A crew of at least 2 persons is needed. These systems can be heavy. Use safe lifting techniques to avoid injury and product damage.

Highly recommended is using an independent NanaWall Certified Installer, if available, or, at least, an installer who has some experience in installing NanaWall systems.

For all projects in FL and/or higher windload areas, the stricter of these instructions and FL37259 Evaluation Report and Installation Drawings should be followed.

IMPORTANT: READ COMPLETE INSTRUCTIONS BEFORE BEGINNING INSTALLATION. INSTALL AS RECOMMENDED; OTHERWISE, THE UNIT MAY NOT FUNCTION PROPERLY AND ANY WARRANTY, WRITTEN OR IMPLIED, WILL BE VOID.

CAUTION:

As regulations governing the use of glazed windows, doors, storefronts, and/or partitions vary widely, it is the responsibility of the building owner, architect, contractor, or installer to insure that products selected conform to all applicable codes and regulations, including federal, state, and local. NanaWall Systems, Inc. can assume no obligation or responsibility whatsoever for failure of the building owner, architect,

contractor, or installer to comply with all applicable laws and ordinances and safety and building codes.

The HSW60 system is shipped with all necessary components. However, not included are screws, bolts, shims, etc. to anchor the unit to the opening. The frame is shipped knocked down and needs to be assembled. Panels are pre-assembled with glass, ready to be attached to the installed frame. In most cases, all rollers, hinges, weather stripping, multiple locking, and flat handles are pre-attached to the panels and frame components.

DESCRIPTION OF SUPPLIED PARTS

First look for an envelope in the shipment, which contains drawings of the elevation and the layout of the unit. This information together with the product drawings provided by NanaWall at the time of order will be needed for a successful installation. As there is no “standard” configuration for HSW60 units, see Diagram 1 and 2 for an example to illustrate the installation process. Diagram 1 show the elevation and layout of an Example with a 4 Panel Unit. Some items may not be applicable for your unit. Inspect the elevation drawing, indicating size, configuration and labeling of the unit ordered.

Check all parts carefully before assembly. Depending on the unit ordered, some of these parts may already be pre-installed on the panels. Check that the sizes of the frame components and panels match with what was ordered.

The elevation drawing shows the sequence and number of panels, which depends on the model ordered. **The drawing is always viewed from the inside.** The panels are pre-assembled with two upper carriers for each sliding panel and with flat handles for the standard locking mechanism. **The sequence of labeling of panels starts from the left looking from inside with the left most panel labeled Panel 1.**

DIAGRAM 1: EXAMPLE WITH A 4 PANEL UNIT

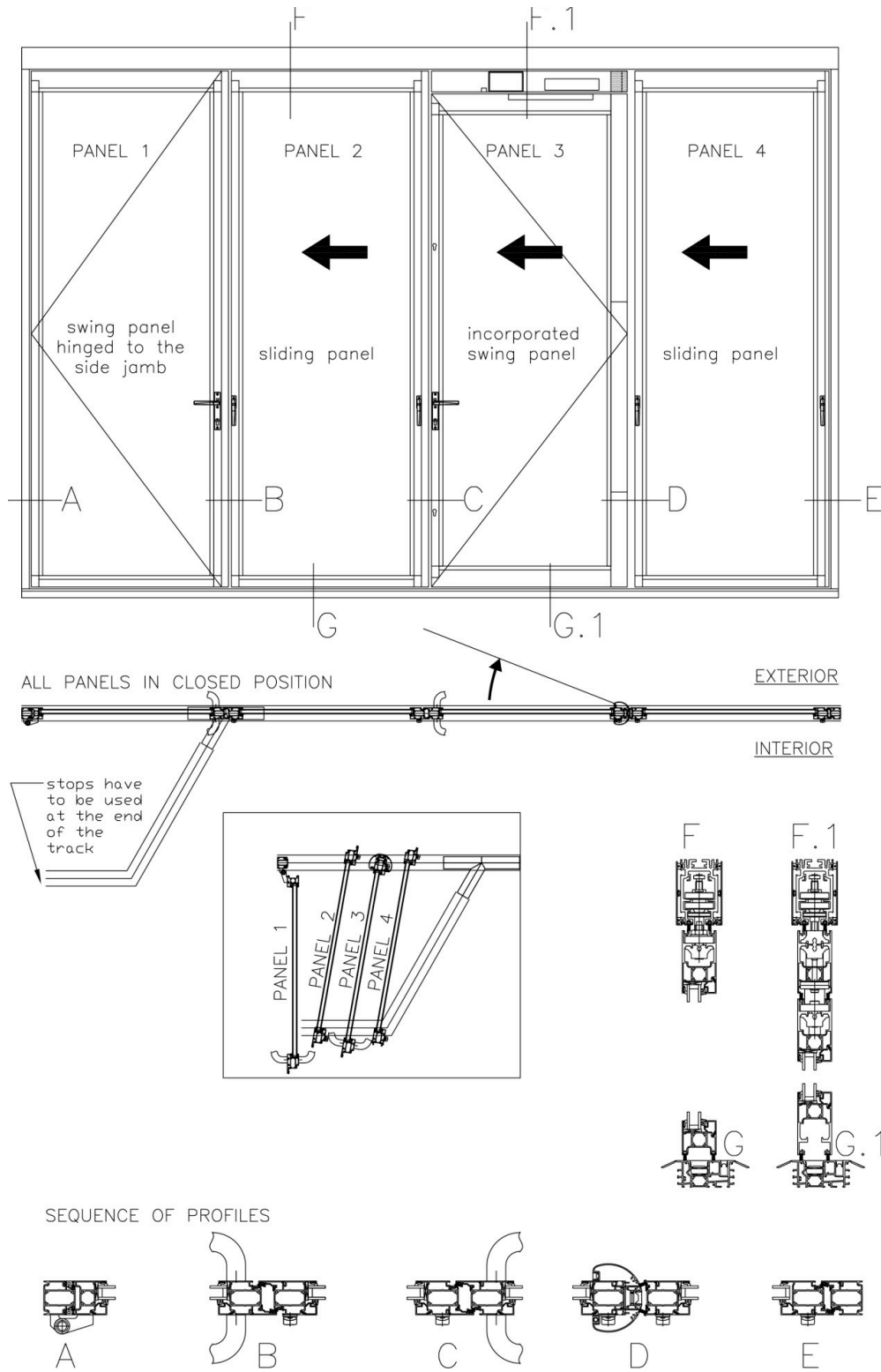

Other components include:

- For swing panels, mortise locksets, and/or deadbolts as per order are pre-installed.
- Lever handles, other handles or other entry hardware as ordered may not be pre-attached to the panels and will be in the hardware box or shipped separately.
- Hinge pins with washers – one for each set of hinges. Please note that the hinge pins may vary in size depending on the connection.
- Left side jamb, labeled L, and right side jamb, labeled R.
- The layout drawing of your unit shows the upper track components consisting of the head track in the opening, the stacking route(s) and the stacking bay(s), how they are labeled and how they have to be connected. The same information for the sill segments is provided, if a unit with a sill was chosen. The joints for the segments are indicated and necessary connectors and set screws for connecting different upper track and sill pieces are pre-attached to one of the two segments to be connected.
- The location of the access slots in the head track to insert the rollers on panels is indicated on the layout drawing. There is also a label on the upper track on the exact location.
- The ends of the stacking bay are covered with plates and have stoppers installed. The stoppers have to remain in place otherwise the panels may slide off the upper track.
- For units with a sill, receivers for the locking mechanisms on the panels are inserted in the sill. If the sill is straight, then all of them could be found at one end. If the sill is segmented, then the necessary number of locking receivers can be found at one end of each segment. A roll of sill gasket is provided with

the correct overall length that is to be cut on site to be inserted in the channel between locking receivers after the locking receivers are placed in the proper position to receive the locking mechanisms.

- For units with NO SILL, adjustable floor sockets are supplied with additional installation information.

HANDLING OF COMPONENTS

1. Upon receipt, inspect the shipment to ensure it is in good condition.
2. Make sure that all components and hardware, which might be shipped separately does not get lost.
3. Store in a clean and dry location and protect against defacement or damage, especially to the edges of panels.

PREPARATION OF THE OPENING AND SUPPORT STRUCTURE ABOVE

Make rough opening about 3/4" wider than the outside unit frame width. The height of the rough opening relative to the unit frame height depends on the installation detail chosen after accounting for the recessing of the sill and the space above the head jamb needed for an adjustable anchorage mechanism or appropriate shim space. Shim space should not be more than 3/4" for projects with design pressures of less than 25 psf and not be more than 3/8" for projects with design pressures of more than 25 psf. See Diagram 3 for Suggested Typical Installation Details. It is important that the opening be the correct size.

Product performance, including air infiltration, water penetration, structural loading and forced entry and operation, depends on having the gap between the bottom of the panel and the top of the sill (or on a unit with no sill, but floor sockets, then the top of the finish floor) be 10 mm (about 3/8").

Note that the outside frame height is measured from the bottom of the sill and not from the finish floor. If a unit with no sill is provided, the frame height is measured from the top of the finish floor.

The track length and layout have been supplied based on the configuration and sizes chosen and approved. Please refer to the layout drawing of your particular HSW60 project for the correct location of the support structure for the support of the head track at the opening, stacking route and stacking bay. It is important that the system is properly supported at the top and at the proper locations.

IMPORTANT: Any application should take into consideration the following:

1. As the HSW system is a top-hung system, it is essential that a proper substrate with the proper size and thickness be used as the support structure not only as support for the head track in the opening but support of the head track at all locations including the stacking bay and stacking route.
2. The structural integrity of the support structure is critical for proper operation. Vertical deflection of the header under full live and dead loads should be the lesser of $L/720$ th of the span and $1/4"$. Structural support for lateral loads (both windload and when the panels are stacked open) must also be provided.
3. A qualified engineer or architect should be used to determine the proper construction details and super structure to be used in your particular application.
4. **THE ROUGH OPENING SHOULD BE LEVEL, PLUMB AND SQUARE AT ALL POINTS. THERE SHOULD BE NO UNEVENNESS OR BOWING. MAKE SURE THAT THE HEADER IS NOT TILTED OR TWISTED. THERE SHOULD BE NO BUMPS ON THE FLOOR.**

THE SIDES SHOULD BE IN THE SAME VERTICAL PLANE AND NOT OFFSET OF EACH OTHER. A TRANSIT/ LASER AND OTHER SIMILAR PRECISE MEASURING EQUIPMENT SHOULD BE USED. You need to adjust the floor at the opening to make it absolutely level.

5. With the low profile saddle sill and the flush sill, if concrete is to be poured after the installation of the unit, the sill has to be securely attached to the construction. If the sill is to be cast in concrete, then an expansion gap with appropriate material has to be created next to the sill.
6. If planning to drill into post tensioned concrete, a structural engineer and architect has to be consulted.
7. With a low profile saddle sill, some resistance to water infiltration may be achieved by installing drain connections to the outside. Contact NanaWall for details.

If any anchorage or drain connection holes are made through these drain channels, make sure that they are properly sealed to prevent any water leakage. The open ends of these drain channels at each end of the sill should also be properly sealed including all areas where the sill parts are joined together. Alternative anchoring systems for the sill are using L brackets attached to both sides of the sill.

8. For a unit **with floor sockets** and no sill, the finish floor will need to be perfectly level with no unevenness. Floor sockets will need to be installed at precise locations after all panels are installed and final adjustments are made. See under D: LOCKING RECEIVER OR SOCKET INSTALLATION. The following points should be considered for the installation of floor sockets in concrete slabs and wood. The substrate should be a minimum of 4" thick. The embedment of the sockets into the concrete or wood should be a minimum of 1". The clear edge

distance in concrete or wood should be a minimum of 1", when the sockets embedment is 2". If the socket embedment is 1", the clear edge distance should be a minimum of 2".

9. Installations into heavy gauge all metal studs must have wood backing.
10. For better performance and protection, any exterior single track sliding system should be installed under an overhang or with other similar protection.
11. For better performance it is strongly recommended that all dead loads such as upper levels, roof, etc. be constructed and reasonable time for it has been allowed to settle before a unit is installed.

Properly flash and waterproof around the perimeter of the opening, especially at the sill. Make sure you seek proper professional advice for the appropriate construction needed for your particular application. Do not install unit in structures that do not allow for proper management/drainage of moisture. Peel and stick or ice shield should be used on all bottom seals.

To avoid future problems, do not install your unit until the rough opening and the support structure have been correctly prepared.

PREPARATION OF THE SUPPORT STRUCTURE ABOVE

Instructions for anchoring the head track with the adjustable anchorage assembly as shown in Details 1 or 2 in Diagram 3.

1. Anchorage of the upper track should be made with appropriate corrosive resistant threaded rods with diameter of 3/8" and with appropriate size nuts and washers that are not smaller than shown in Diagram 2. In the groove that is at the top of the upper track, a typical standard nut with dimensions that fits in the groove (not to exceed 11/16" (17.5 mm) in width and 7/16" (11 mm) in height) should be used. As shown in Diagram 2, the maximum distance between the top of the upper track and the header should not be more than 1-9/16". Please see Diagram 5 for proper spacing of the threaded rods in the opening using the steel material specified. The proper spacing depends on the design wind load and the unit height. The spacing of the threaded rods in the stacking bay should be every 4" and in the stacking route every about 18". Please see Diagram 4.

DIAGRAM 2: ADJUSTABLE ROD ANCHORAGE SYSTEM DETAIL

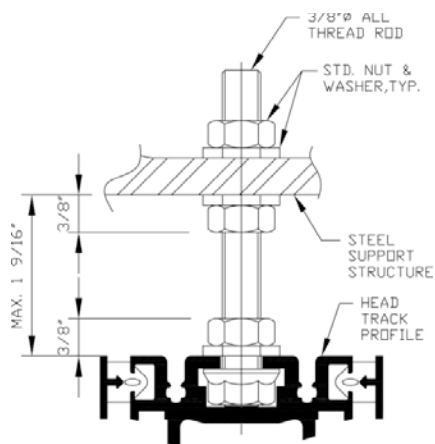

2. Please note that the holes in the support structure have to be drilled before the frame is set in the opening. If steel is used, it is recommended that all anchorage holes in the support structure be prepared by the steel supplier before installation of the steel structure. Please make sure that the structural integrity of the steel is still intact.
3. Determine the location of all anchorage points on the support structure. Make sure the points chosen correspond to where the center of the upper track is to be placed in relation to the support structure as shown in any detail drawings provided by the architect or owner.
4. As the nuts to be placed in the upper track groove can only be placed along the length of the profile and since some tolerance in the drilling of the holes in the steel structure must be allowed, it is recommended that oblong holes be made as shown in Diagram 4.

For anchoring the head track with screws through the head track as shown in Detail 3 in Diagram 3, please see Step A4.

Do not install your unit until the support structure has been correctly prepared.

DIAGRAM 3: HSW60 SUGGESTED TYPICAL INSTALLATION DETAILS

Suggested Typical Installation drawings shown are very general and may not be suitable for any particular installation. Product placement, fasteners, flashing, waterproofing, sealant, trim, and other details for specific surrounding conditions must be properly designed and provided by others.

Drawings not to scale.
Details shown are subject to change without notice.

Detail 1: HEAD JAMB with a adjustable rod anchorage system.

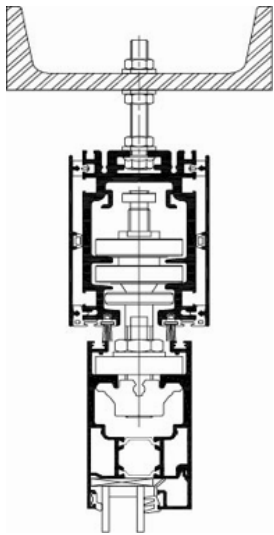

Detail 2: HEAD JAMB with adjustable rod anchorage system and steel "C" channel.

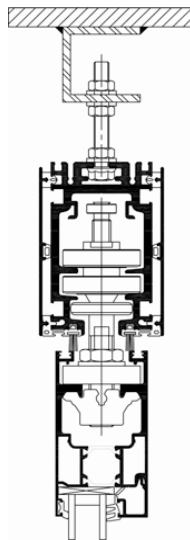

Detail 3: HEAD JAMB with hard plastic shims between head jamb and header. (This detail is not recommended for larger openings or larger panels in which the adjustable rods make adjustment easier.)

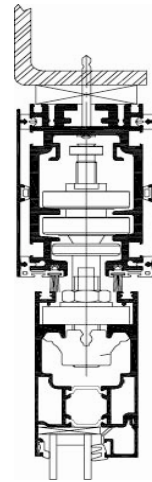

Detail 4: FLUSH SILL (no rating against wind driven rain)

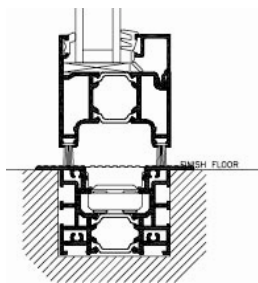

Detail 5: LOW PROFILE SADDLE SILL (for some resistance against wind driven rain, drain connection by others necessary)*

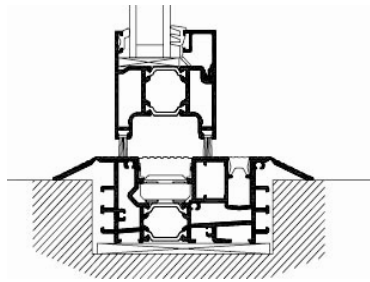

Detail 6: ADJUSTABLE FLOOR SOCKET (no rating against wind driven rain)

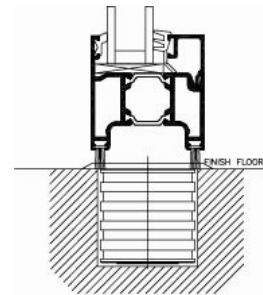

Detail 7: SIDE JAMB MEETING SLIDING PANEL

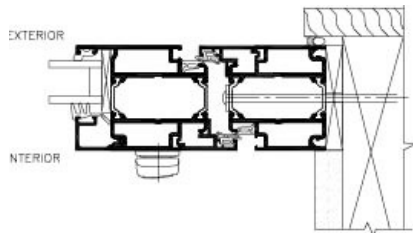

Detail 8: PANEL HINGED AT SIDE JAMB

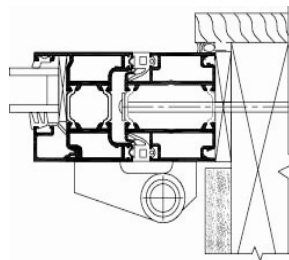

*Generally as follows:

1. Remove the gasket covering the inner channel
2. Provide necessary weep holes at the bottom of channels and on the outside face of the sill.
3. Make necessary drain connections
4. Contact NanaWall for a detailed drawing

DIAGRAM 4: VIEW FROM THE TOP OF A TYPICAL STEEL SUPPORT STRUCTURE

View from the top of a Typical Steel Support Structure showing oblong slots for Anchorage of Upper Track with Adjustable Rod Anchorage System. See Diagram 6 for correct spacing in the opening.

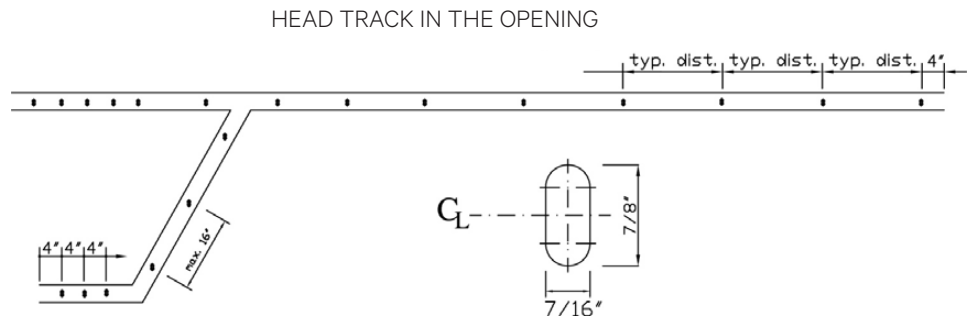

A. FRAME ASSEMBLY AND INSTALLATION

Since there can be an infinite number of variations of stacking options and configurations, it is not possible to have step by step specific instructions that will apply to all units installed. Below are general instructions that may not exactly apply to your particular unit. Please refer to the architectural drawings, product drawings or layout diagrams for your specific project.

 **The key to having a properly installed and operating HSW60 system is to install a perfectly level upper track at the correct height from the finish floor and having the upper track precisely aligned to the lower track.**

Step A1

Look for the labels on the different upper track segments and set them on the floor as per the layout drawing/cutting list of the head track profile SL5-60-20.

Step A2

For the upper track segments to be joined together, if the aluminum cover profile SL5-60-21 was provided, remove from both sides. Make sure they are marked, so they can be re-attached to the correct upper track later.

Find the roller access slots on the upper track through which the carriers on each panel will be inserted. A label shows the exact location. It should be a cut in the track about 2-3" wide. Access could also be from the ends of the head track in the stacking bay. To open the slot, first pry open the upper track cover, then loosen the set screws on the connector piece and move it to one side.

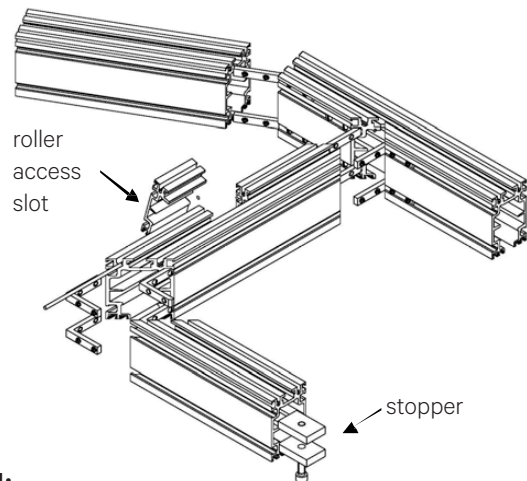

ILL. 1:
Connection of Head Track Profile SL5-60-20

**DIAGRAM 6:
SPACING FOR STAINLESS STEEL THREADED
RODS ADJUSTABLE ROD ANCHORAGE SYSTEM
AT UPPER TRACK**

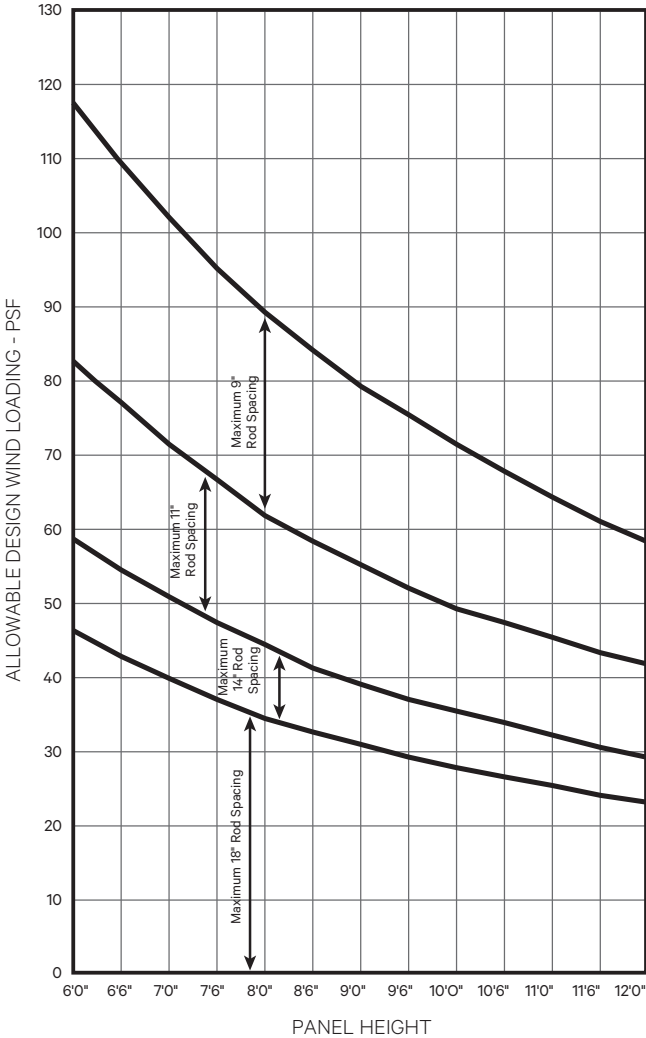

NOTES

1. Treaded rod material to be Series 300 stainless steel with FY = 50 ksi minimum and Fu = 100 ksi minimum.
2. Nuts and washers to be stainless steel, compatible with rod material.
3. Rod exposed length between the top of the head jamb and the header to be a maximum of 1 9/16"

**DIAGRAM 7:
SPACING FOR INSTALLATION FASTENERS
DIRECTLY INTO MASONRY BLOCKS AND
CONCRETE**

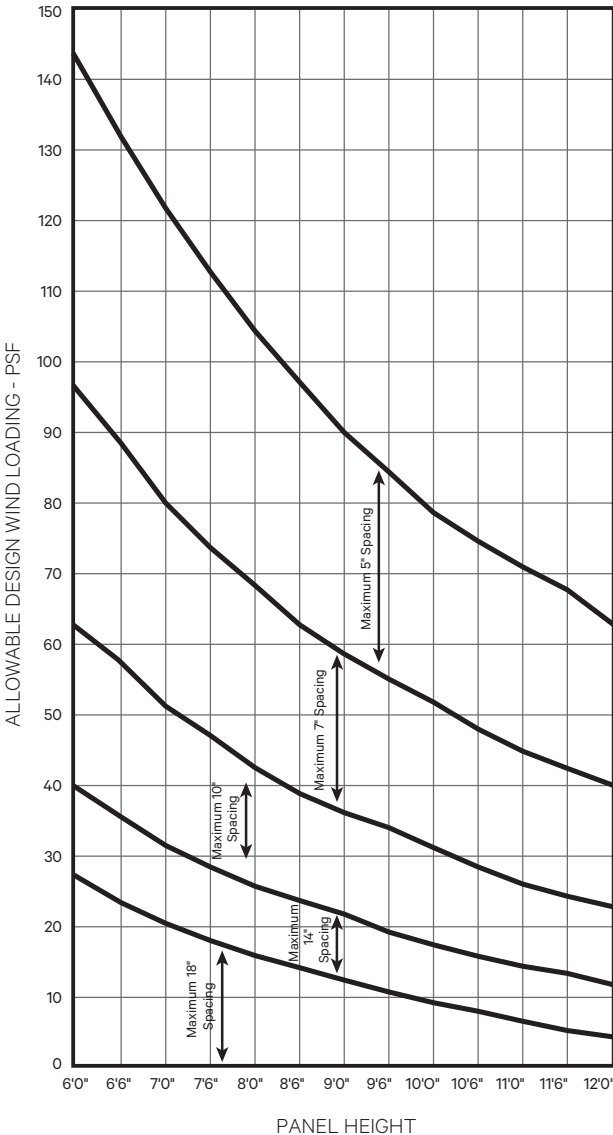

**DIAGRAM 8:
SPACING FOR INSTALLATION FASTENERS
DIRECTLY INTO WOOD**

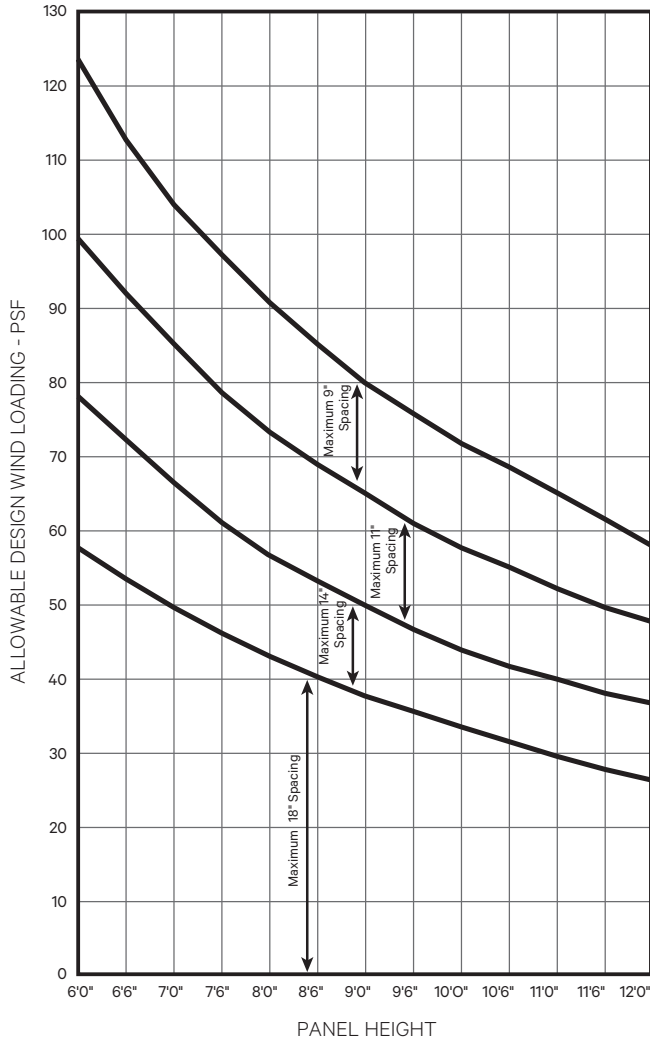

**DIAGRAM 9:
SPACING FOR INSTALLATION FASTENERS
DIRECTLY INTO STEEL (14 GAGE MINIMUM)**

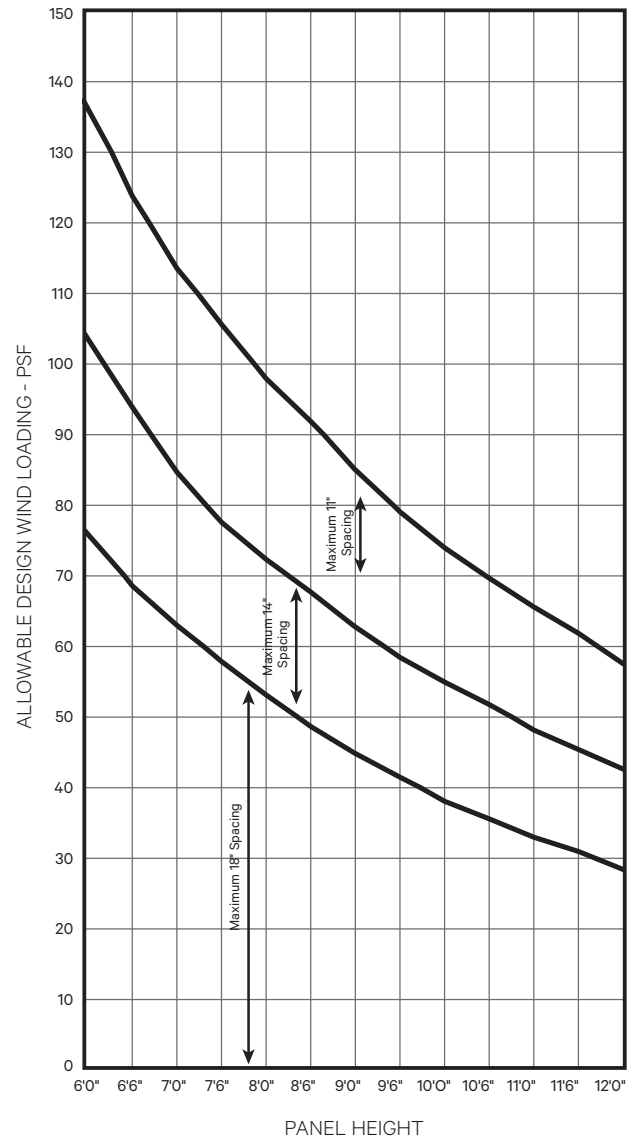

Step A3

Attach as many of the upper track pieces together that could be supported and installed easily as one piece. Use the connectors and set screws provided. See Illustration 1. Make sure that the correct angles between segments are maintained.

Step A4

For anchoring the head track with screws through the head track as shown in Detail 3 in Diagram 3, pre-drill anchorage holes in the head track.

Please see Diagrams 6, 7 and 8 for correct fastener spacing in the support structure within the opening. This depends on substrate material, Design Windload pressures of the project, and the panel height.

The spacing of anchorage devices in the stacking bay should be every 4" and in the stacking route about every 18". Please see Diagram 4.

Use appropriate screws or other equivalent anchorage devices depending on the adjacent substrate material and construction. Make sure they are corrosion resistant and that the screw head is small enough to fit inside the slot in the middle of the head track; otherwise, it will interfere with the running carriages. Anchorage devices should penetrate or hold sufficiently to the opening to withstand necessary structural loading. Generally, for wood frame, use #14 (1/4" diameter) wood screws with 2-1/2" minimum embedment, for concrete with a minimum compressive strength of 3,200 psi use 1/4" diameter ITW Tapcons (concrete screws) with 1- 1/4" min. embedment and min. edge distance of 1 1/2", for masonry use 1/4" diameter ITW Tapcons (masonry screws) with 1-1/4" min. embedment and min. edge distance of 2", for light gage steel substrates with a minimum of 14 gage (0.075" thick) use 1/4" diameter type 300 stainless steel self drilling screws and for structural steel substrates thicker than 1/4" use 1/4" diameter SAE Grade 2 bolts with holes that are pre-drilled. Another option in structural steel substrates is to use type 300 stainless steel self drilling screws with small pilot holes that are pre-drilled.

Step A5

For all anchorage options, set the assembled part of the upper track into the rough opening at the proper position relative to the super structure and the finish floor.

Step A6

Support the upper track temporarily in a safe manner with, for example, construction posts or with straps/ropes tied around the header.

Step A7

If the adjustable rod anchorage system is used, then loosely attach the threaded rods with all necessary washers and nuts to the oblong holes in the support structure. Anchor the upper track to the support structure by screwing the threaded rods into the nuts, which are in the groove on top of the head track. Lock them safely with nuts and washers on the top of the head track profile.

For anchorage with screws through the upper track, place hard plastic horseshoe shims tightly at every fixing point between the upper track and the header. Anchor the head track with appropriate screws through the pre-drilled holes.

Step A8

Assemble and install other segments of the upper track in a similar manner.

Make certain that the angles between different upper track components are exact.

If the stacking bay has parallel legs, make sure that the legs are exactly parallel. The aluminum plate provided to connect the ends help to insure this.

IMPORTANT: ADJUST EACH ANCHORAGE POINT AS NEEDED TO MAKE THE UPPER TRACK ABSOLUTELY LEVEL AND PLUMB. USE A TRANSIT/LASER AND OTHER SIMILAR PRECISE MEASURING EQUIPMENT TO MAKE THESE DETERMINATIONS.

Step A9

If there is a sill provided for the unit, the first step of assembling the sill will be to look for the labels on the different sill segments and set them on the floor as per the layout drawing.

Step A10

Starting at about 4" from each edge, drill holes for anchorage devices to connect the sill to the opening at the same spacing that is used for the head track as described in Step A4 above. Use appropriate screws and anchorage devices as described in Step A4 above.

Step A11

Attach as many of the sill pieces together that could be supported and installed easily as one piece. Use the connectors and set screws provided. Make sure that the correct angles between segments are maintained.

Step A12

Set sill in place; make sure it is in the correct position and is plumb and aligned with the upper track. Make sure that the correct height between the sill and the head track is maintained.

Shim the sill as needed with hard plastic horseshoe shims located at the pre-drilled holes to make sure it is absolutely level. If there are bumps or unevenness in the floor, they would need to be evened out so that the height for the unit remains the same. Use hard plastic horseshoe shims only.

Anchor the sill through the pre-drilled holes and shims. Penetration should be as described in Step A4. Make sure that all holes drilled through the sill are properly sealed with for example silicone underneath and around the screws.

If a unit is supplied with NO SILL, do not make any socket holes in the floor yet!

Step A13

Installing the side jambs:

Pre-drill holes for the anchorage devices to connect the side jamb to the opening at the same spacing that is used for the head track as described in Step A4 above. Use appropriate screws or anchorage devices as described in Step A4 above.

Step A14

Set the side jamb in place and align with the sill. See Illustration 2. Support them temporarily with clamps.

ILL. 2:

Connection of Side Jamb and Sill

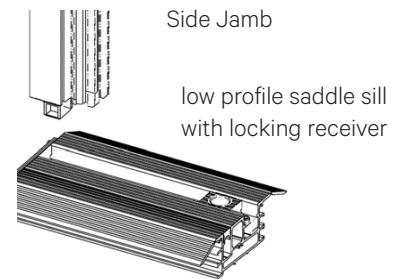
**Step A15**

Place hard plastic horseshoe type shims tightly at every anchorage point between the side jamb and the wall to make the side jamb absolutely square and straight. Anchor the side jambs through the pre-drilled holes and shims.

If anchoring through the center of the thermal break, make sure the screw or bolt head with washer bears on the aluminum. To maintain the thermal break, use PVC or nylon washers so that the screw heads do not bridge the aluminum.

IMPORTANT: Make sure no shims are forced to ensure that the frame sections are not bowed. Check frame constantly to be certain that it is level, plumb, and square. A transit/laser and other similar precise measuring equipment should be used to make these determinations. Make sure that all surfaces of the upper and lower tracks are clean and free of any debris, especially cuttings from drilled holes.

B. PANEL INSTALLATION

As there can be many possible configurations, panel installation will vary with each unit. Below are general guidelines. Look for the glass stops to determine the interior side of a panel.

Step B1

Looking at the elevation drawing, if there is a swing panel attached to the side jamb, align the hinge components and install the panel with the hinge pins.

Step B2

Check all the carriers on all the panels. Make sure all the locking nuts are securely tight. Do not make any adjustments on the carriers.

Step B3

Hang panels not attached to a side jamb by inserting the carriers on each panel into the roller access slots in the upper track in the proper sequence.

Step B4

Install additional panels and incorporated swing panels in the same manner.



CAUTION! Do not use the crank handle to disengage the upper arm of the top rail of the incorporated swing panel until all the panels and locking receiver or sockets are installed and in place. The upper arm of the top rail has to be secured to the head track via the Conversion Box and the lower locking rod on the pivot side has to be secured to the locking receiver in the sill or socket in the floor before the incorporated swing panel can function properly. Otherwise, it will not be stable and can fall and hurt somebody. See Operation Instruction label in the circular pocket on the stile of the incorporated swing panel.

C. GAPS AND ADJUSTMENT

After inserting and sliding all panels in the closed position, check if all panels are vertically straight. Between panels there should be an even gap of 10 mm (about 3/8") from top to bottom. Any problems may be due to the side jambs not being plumb or the head track not being absolutely level. A difference of 1/16" or less in the level of the head track between the two corners of a panel can cause a 1/4" shift of the panel from the vertical position enough for a panel not to close properly.

The horizontal spacing between the upper track and the top of a panel and between the bottom of a panel and sill or finish floor (if there is no sill) should be 10 mm (about 3/8").

If the gaps are not correct, then adjust the side jambs or upper track. The upper track has to be perfectly level. **UNDER NO CIRCUMSTANCES SHOULD THE CARRIERS/ROLLERS BE ADJUSTED.**

D. LOCKING RECEIVER OR SOCKET INSTALLATION

For units **with a sill**, move all the locking receivers so they are in the correct position below the locking rods. **Make sure that the special locking receiver for the incorporated swing panel pivot side locking rod are in place.** Tighten the screws. Close and lock all the panels. Move and adjust the locations of the locking receivers as needed.

For units with **no sill**, holes in the floor for the sockets have to be made at exact precise spots. There is no second chance if the hole location is off. Once a panel is in the correct position, turn the handle cautiously and mark the correct locking spot on the floor before drilling.

Follow the separate installation instructions that are provided with the floor sockets.

E. FINAL STEPS

Step E1

Close and lock all panels into position. For incorporated swing panels, make sure the receiver on the head track for the attachment with the Conversion Box on the upper arm of the top rail is aligned to the Conversion Box.

Step E2

Check all vertical and horizontal joints and adjust them as described under section C: GAPS AND ADJUSTMENT. Move and adjust the locking receiver or floor sockets as needed.

Step E3

Attach handles and other hardware that have not been pre-attached. Attach the profile cylinder (if any) to the locking gear by inserting it into the lock hole and attaching the set screw through the screw hole on the gear located at the edge of the panel. Cut the set screw, if needed, so it is not longer than 1-1/2".

Step E4

Check that the system operates and functions properly. Open and close all the swing panels.

Convert sliding panels to incorporated swing panels by turning the handle inside the special circular stile to engage the lower locking rod. Then use the crank handle on the Conversion Box to disengage the top rail from the upper arm and engage the Conversion Box to the head track. See CAUTION in section C above.

The panels should move easily in the opening and should stack smoothly in the stacking bay. Check to see if all upper track components are properly installed. Check if all angles are correct. Each leg of the stacking bay track should be equidistant at all points. Spray the carriers as needed with the lubricant provided or use Teflon spray for smooth movement. When opening or closing, all shoot bolts should engage smoothly.

Step E5

Reattach the aluminum cover profiles on the upper track.

Step E6

For a unit with a sill, measure and cut to the proper lengths the gasket to be installed in the channel to cover the space between the locking receivers.

Step E7

Correct any problems before finish trimming. While finishing trim and eventually dropping the ceiling pay attention to roller access locations. The head track should not be subject to any loads from suspended ceilings, etc.

Step E8

Apply a thick bead of exterior grade sealant with a backer rod if needed on the joint between the sill and floor on both sides along the length of the sill. Do similar for the gaps between the head jamb and side jambs with the opening.

Step E9

Finish any waterproofing, flashing, trim, and sealant needed around the perimeter of the opening.

Step E10

Important: If any weep holes were done in the sill by others, then make sure that they are not blocked.

PROTECTION OF UNIT DURING CONSTRUCTION PHASE

It is important that during the construction phase the unit be kept closed, covered and protected from damage. During this phase, a unit is often subject to the most extreme conditions from all types of construction operations that can permanently damage and destroy it. A unit can be damaged by cement splatter, tar, paint, weld splatter, falling objects, construction dust, sand blasting, etc. All temptations to use the large opening of an installed system for easy ingress and egress by tradesmen should be resisted.

Operation And Maintenance Of NanaWall Products

OPERATION OF A NANAWALL HSW - SINGLE TRACK SLIDING SYSTEM

For opening and closing the single track sliding system, please observe the special notes on the following pages in as far as they relate to your unit.



When operating the system similar to any other door, please do not place your fingers between the panels/pivot points.

Only properly trained personnel should operate the unit.
No children should operate the unit.

Do not force the system if not operating properly. Please have it repaired as soon as possible by a qualified technician.

Secure panels when in the open position to prevent uncontrolled movement, especially in windy conditions, that might cause damage and injury.

Be sure not to operate the doors in high wind conditions.

It is highly recommended that if not used, the NanaWall unit be kept closed as much as possible. When closed, please engage all locking mechanisms fully. This will provide best security, weather resistance and resistance against warpage.

The correct sequence of opening and closing of panels is dependent on the configuration ordered. Panels must be opened and closed in the right order.

Opening and Closing a Unit

- For opening, if there are any incorporated swing panels (HSW60), convert the incorporated swing panels to sliding panels as per instructions on the next page. **IMPORTANT:** Correct procedure must be followed.
- For Swing/Slide units (HSW66), open the swing panels first. **IMPORTANT:** The swing panels must be opened all the way and must engage them into the panel catch on the adjacent panels.
- If there are swing panels or wiggle panels attached to the side jamb (not incorporated swing panels), open these panels first.
- Disengage the locking points on all the other panels.
- Note that there is a carrier at each upper corner of a sliding panel. Look at the head track within the opening and note the switches that lead the head track from the main opening to the stacking bay. Guide the closest carrier of a panel through the appropriate switch and slide that panel into the stacking bay. Attention: Move only one panel at a time.
- Similarly, slide all the remaining panels through the appropriate switch into the stacking bay.
- In most cases, panels can be pushed in place with one hand pushing on a stile. Move evenly and keep panels as vertical as possible and push into the stacking bay. Do not force. Avoid any pendulum movements, otherwise rollers may get damaged.
- If there is more than one stacking bay, please be sure the panels are stacked in the correct stacking bay.
- For closing, proceed with the sliding of the panels in reverse order. To pull the panels from the stacking bay, you will need to pull the stiles of the panel. Move evenly and keep panels as vertical as possible. Avoid any pendulum movements.
- Make sure each panel is placed in its proper position in the opening.

11. Engage all the locking points. Do not force any locking point.
12. Convert the incorporated swing panels (HSW60) from sliding panels to swing panels as per instructions below.
13. For SwingSlide units (HSW66), the swing panel should not be disengaged from the panel catch engaging it with the adjacent panel until all sliding panels are properly closed and all locking points engaged, especially the locking through the concealed operator at the side of the panel adjacent to the swing panel.

Conversion of an Incorporated Swing Panel from a Sliding Panel to a Swing Panel

1. When the unit is closed by moving all panels into the proper position in the opening, make sure all the locking points on every panel are properly engaged, especially the locking points on the incorporated swing panels. The flat handle to engage the lower locking point on the incorporated swing panel is found behind the circular pocket on the stile on the pivot side. Turn this handle 180°.

IMPORTANT: The lower locking point on the pivot side of an incorporated swing panel has to be secured to the locking receiver in the sill or socket in the floor before the incorporated swing panel can function properly. Otherwise, it will not be stable and can fall and hurt somebody.

2. Using the crank handle found in the circular pocket on the stile on the pivot side, turn the slot in the Conversion Box located on the upper arm of the top rail so the upper arm engages to the head track and disengages from the top rail to release the swing panel. Stow the crank handle in the circular pocket.
3. The incorporated swing panel can now be used as a regular swing door with appropriate hardware.

Conversion of an Incorporated Swing Panel from a Swing Panel to a Sliding Panel

1. Close the swing panel.
2. Using the crank handle found in the circular pocket on the stile on the pivot side, turn the slot in the Conversion Box located on the upper arm of the top rail so the upper arm disengages from the head track and engages to the top rail. Stow the crank handle back into the circular pocket.
3. Turn the flat handle found behind the circular pocket on the stile on the pivot side to disengage the lower locking point.
4. The incorporate swing panel can now slide away just like all the other panels

OPERATING THE SL-MULTIPOINT LOCKING ON THE PRIMARY SWING PANEL(S)

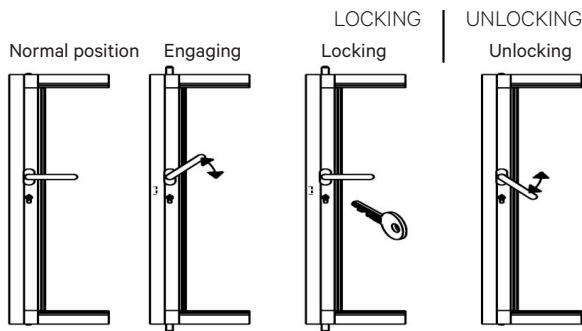

Disengaging locking points
 (Note that this is not one motion operation. Key or thumbturn must be unlocked first.)



Be sure to check that the door is locked.
 The door is locked, when the handle cannot be depressed.

Engaging the locking points and locking

- Turn handle up about 45° to engage the locking points. Then let it move back into its normal position.
- Only now can it be locked with a key on the outside or a thumb turn on the inside.

Unlock and disengaging the locking points

- Unlock the lock with key or thumb turn.
- By operating the door handle downwards, the locking points at the top and the bottom are disengaged.

RECOMMENDED MAINTENANCE OF NANAWALL PRODUCTS

Some General Considerations on all Projects:

1. It is important that the product is properly installed. A poorly installed unit will not function properly. This will cause more abnormal force or stress on the components and will lead to premature failure. When operating the unit, the panels should generally be able to be moved easily by one person (except when there are very large panels or when there are more than 6 panels folding to one side). All locking points should engage smoothly. There should be no rubbing on the floor and no binding. When the unit is closed, the reveal between panels and head jamb and between panels and sill should be consistent. There should be no daylight seen from the inside. Please have all problems corrected as soon as possible by a qualified technician.
2. From time to time, due to building movement or settlement, a unit may need to be adjusted by a qualified technician to compensate for any building change.
3. It is important that a unit is operated properly. Locking points should be gently opened and closed and not forced. Panels should be opened and closed in the proper manner and sequence. See the Operation section for proper operation.
4. Periodically check for worn or damaged components and replace as soon as possible. A unit with nonworking components will subject the other components to increased stress and lead to premature failure. A unit with worn or damaged components will compromise the performance level expected for air and water infiltration, structural loading and forced entry.

5. Periodically, inspect the sealant/caulking on the exterior perimeter of the unit. It is extremely important that the sealant/caulking remains intact and in good condition. Trim off any old, loose caulking and seal any gaps with a good quality caulk.
6. Check that all weep holes are clean and clear of any obstructions. Remove debris and other foreign bodies which have dropped into the tracks in the head jamb and sill immediately to prevent damaging the running carriages and guide trolleys (if any). Clean all components as needed. Check gaskets for proper seating and condition. Remove dust and any deposits from these gaskets.
7. The finished aluminum or wood surface needs periodic cleaning and maintenance. Its appearance may be marred by harsh chemicals, abuse or neglect. Frequency of cleaning depends on exposure and needs. For aluminum surfaces, generally warm soapy water should be sufficient. Stubborn stains and deposits may be removed with mineral spirits. For wood surfaces, superficial surface dirt can be removed by washing with water and a soft-bristled, long-handled brush. Heavier accumulations can be removed with a mild solution of household detergent. For all surfaces, aggressive alkaline or acid cleaners should not be used. Excessive abrasive rubbing should be avoided. Sealants and weather stripping may be affected by strong organic solvents. Superficial damage to the aluminum surface must be touched up immediately with proper touch up paint.
8. If it is a wood product, periodically repaint or restain the wood as needed. Exposure to the environment will break down the finish and compromise its protective features if not refinished. See Finishing Recommendations in the Owner's Manual of the wood systems.
9. All hardware, hinges, and handles should be periodically cleaned with a soft cloth and mild cleanser. Excessive abrasive rubbing should be avoided. Please note that oil rubbed brass is a finish that will develop its own unique patina over time.
10. About every six months, apply lubricant to all the hinges and Teflon spray to the running carriages and guiding trolleys.

SOME SPECIFIC SUGGESTED MAINTENANCE FOR COASTAL SALT WATER AND OTHER EXTREME ENVIRONMENTS:

Please note that the environment within one mile of a sea coast can be extremely corrosive. Products installed in this environment will typically deteriorate sooner than products installed in a less severe environment.

1. Open and close completely a unit at least once a week and inspect all surfaces.
 - a. Salt and other corrosive or abrasive materials such as sand must not be allowed to build up on any surfaces, including all hardware and sill.
 - b. The sill and head jamb tracks should be free from all dirt and debris.
 - c. There should be no standing water in the track in the sill.
 - d. All hardware should be intact and operating properly.
2. All surfaces must be cleaned with a mild detergent soap and fresh water at least every month and more frequently if necessary.
 - a. After washing, the surface should be rinsed thoroughly with clean water and allowed to dry.

- b. For cleaning, do not use abrasive household cleaners or materials like steel wool or hard brushes that can wear and harm finishes.
 - c. Any glass cleaner used should not be allowed to run down on any other surface.
3. Any breaches in the paint coating, such as scratches, chips or areas of abrasion, must be repaired immediately.
 4. Every 3 months, thoroughly clean and dry all upper and lower rollers and all hinges. Liberally apply lubricant such as Teflon spray (no grease) on the wheels and bearings of the rollers. Oil all hinges including the hinge pin with light weight lubricating oil or Teflon spray.
 5. As with any painted surface exposed to corrosive environments, every 6 months apply a wax to the outside of the painted panel and painted track. If the system includes corner connections make sure the wax penetrates the connection joints.

CLEANING AND CARE OF STAINLESS STEEL HARDWARE ON NANAWALL PRODUCTS

Stainless steel is an inherently corrosion resistant material, but some routine maintenance and cleaning is needed to keep surfaces in good condition so that the aesthetic appearance and corrosion resistance are not compromised.

Initial Cleaning

It would be best to protect all stainless steel hardware in the construction phase so that there is no damage. However, if there has been exposure, the following is recommended:

Mortar and cement splashes can be treated with a solution containing a small amount of phosphoric acid or

a proprietary stainless steel cleaner with phosphoric acid. Rinse with water (preferably deionised water) and dry. Never allow mortar removers or diluted hydrochloric acid to be used on stainless steel.

Iron particles picked up from tools or from contact with structural steel, etc. must be removed immediately. Steel dust particles created during operations such as welding, cutting, drilling, and grinding of carbon steel will rust quickly and must be removed.

At an early stage, light deposits can be removed mechanically using nylon scouring pads, such as those used in the kitchen. Alternatively the contamination can be removed with a proprietary stainless steel cleaner containing phosphoric acid.

Maintenance Cleaning

Stainless steel may be exposed to a wide range of aggressive environments such as coastal salt water, industrial pollutants, salt spray from road de-icing salt and atmospheric dirt. All cause brown staining to appear. During routine cleaning of at least every month and more frequently if necessary, all accumulations of airborne contaminants, such as airborne chlorides, salt or sulfur oxides, should be removed. In less aggressive environments, cleaning can be less frequent, such as every 3-6 months. Also finger marks should be routinely removed.

To remove fingerprints and other marks, soapy water or a mild detergent are usually safe and successful.

For more stubborn stains, mild household cream cleansers should be effective. This should also be suitable for cleaning off watermarks and light discoloration. After cleaning, remove the residues with deionised water and dry to avoid streaking and water marks.

Nylon pads can be used (such as those from 3M). When using nylon pads make sure you follow the original grain

of the stainless steel surface. Maintain rubbing in a straight line or the surface will appear scratched rather than grained. DO NOT use cleaning steel wool, wire brushes, metal scouring pads, hard scrapers, or knives as the underlying stainless steel surface may become scratched or unwanted contaminants may be deposited on the surface of the stainless steel. To avoid “cross contamination” from iron particles, ensure that cleaning utensils have not been used to clean other types of steel.

Alternatively, use a proprietary stainless steel cleaner containing phosphoric acid to remove contamination, rinse with deionised water and dry. It is advisable that the entire surface is treated so that a patchy appearance is avoided.

Cleaners that should not be used on stainless steel include chloride-containing cleansers, especially those containing hydrochloric acid, hypochlorite bleaches, and silver cleaners.

GLASS INSTALLATION AND GLAZING

This section applies only if you need to install glass for any reason or if glass setting blocks need to be adjusted. Proper glass installation is critical, as, with the NanaWall single track sliding system, glass is a structural part of the panel.

Glass stops and glazing gasket are to be used for “dry” glazing of each panel. Also needed are setting blocks. **Use glass setting blocks with varying thickness made from hard plastic. Rubber setting blocks are not acceptable.** Width of setting blocks should be at least 1/8" wider than the glass thickness and 1/16" to 1/8" less than the width of the glazing pocket. Setting blocks should be about 4" long.

Glass, with appropriate dimensions, thickness, and specifications will be needed. Depending on the model, widths of all glass panels may not be equal. Contact NanaWall for the glass dimensions. Please note that glass is required to be fully tempered unless the unit is a window placed above a certain height from the floor. Check with all applicable codes and regulations.

Float glass, including the glass components of insulated glass, shall meet the current requirements of ASTM C 1306 “Standard Specifications for Flat Glass” for quality, thickness and dimensional tolerances. Tempered float glass shall meet the current requirements of ASTM C 1048 “Standard Specifications for Heat-Treated Flat Glass - Kind HS, Kind FT Coated and Uncoated Glass.” All tempered glass shall have a permanent logo, which signifies Safety Commission 16 CFR-1201 and the safety glass test requirements of ANSI Z 97.1 (current editions). Insulating Glass shall meet the requirements of ASTM E 774, Class A, B or C.

Although glass installation with the “dry” glazing system is relatively straight forward, it is recommended that an experienced glazing contractor be used.

It is **very important** that the bracing direction and placement of glass setting blocks be correct. Setting blocks for swing panels are to be placed only at one set of opposite diagonal corners whereas setting blocks for individual sliding panels are placed at all four corners. For swing panels, setting blocks are placed at the upper corner on the side where the handle is and at the lower corner on the side where the hinges are. If not correctly braced, the unit will not operate properly. See Diagram 1 for an example with a typical 4 panel unit.

Follow all proper applicable glass installation and glazing techniques as recommended in the Flat Glass Marketing Association (FGMA) “Glazing Manual” and “Sealant Manual”. Always use suction cups to shift glass within an opening. It would be best to install the glass on the panels before they are installed in the opening. Panels can be laid flat on sawhorses. If the panels are already installed, they can still be glazed.

1. Close all panels and secure them with the multiple lock bolts. Start with a panel on one side.
2. Remove all glass stops on the panel. Be sure to protect the finish.
3. Measure both the vertical and horizontal dimensions of the glass and the panel opening. Subtract the vertical glass size from the vertical panel opening size. Divide the difference by two. This will give the nominal thickness of the setting block to use at the top and bottom rails. Several setting blocks of different thickness may need to be combined to obtain the desired thickness. Do the same for the horizontal dimension to obtain the thickness of the setting block to use at the stiles.

4. If it is a swing panel, place a setting block (or combination of setting blocks with desired thickness) on the bottom rail of the panel opening such that it is about 2" from the bottom corner that is on the same side as the hinges.

Carefully place the glass in the opening, making sure it rests on the setting block. With insulated glass, make sure that both inner and outer panes are supported evenly.

Place a second setting block in the same corner as the first, but in the vertical direction along the stile such that its edge is about 2" above the corner.

Place the third setting block in the upper diagonal corner vertically on the opposite stile in the same manner. Then place the last setting block for a swing panel on the upper rail on the same corner as the other upper setting block. To get a proper fit, shift the glass weight by lifting the glass panel up with a plastic pry bar at the lower corner below the upper setting block. These setting blocks should all fit snugly but should not be forced. Adjust the thickness of the glass setting blocks such that the panel is slightly out of square. The upper corner with the setting blocks should be about 1/16" to 1/8" higher than the other corner.

5. For an individual sliding panel, place setting blocks on the bottom rail about 2" from the bottom of each corner. Carefully place the glass in the opening, making sure it rests on the setting block. With insulated glass, make sure that both inner and outer panes are supported evenly.

Then place setting blocks in these corners in the vertical direction along the stile such that its edge is about 2" above the corner, proceed in the same manner on both upper vertical corners. For an individual sliding panel, place setting blocks on both corners of the upper rail.

If necessary, apply a little adhesive that is non-damaging to the glass edge seals such as Dow Corning 791 silicone, to keep the vertical setting blocks from slipping. Make sure that the drainage in the panel is not obstructed by adhesive or glass setting blocks. If the panels are large (over 8 feet tall), additional setting blocks are needed midpoint on the stiles, especially on a swing panel. Ensure that these blocks have the correct thickness and the vertical styles are still parallel and not bowed.

6. For aluminum systems insert the glass stops so that they snap into the panel profile. For wood systems insert the glass stop firmly into position, so they are flush with the panel. Nail to the inner side of the panel with small finish nails. Start with the top and bottom stops and then the sides.
7. Insert the glazing gasket in the space between the glass and the glass stop. First, cut the gasket to a length a little longer than the actual length of the glass stop because gasket material may shrink at low temperatures. Do not stretch or pull the gasket in any manner. If necessary, use soapy water to lubricate the gasket to make insertion easier.
8. Make sure that the stops are locked firmly and securely into position and are flush with the rest of the panel profile.
9. After installing the panels, assuming that the head jamb and sill are level, check to see if the gap between the panel and head jamb and panel and sill is even across the width of the panel. With the glass weight, the out of square swing panels should become almost even. If they remain slightly higher in the upper corner with the setting blocks it is okay. If not, then the lower and upper setting blocks thickness need to be adjusted. Panels have to be braced correctly for proper operation.

DIAGRAM 1: EXAMPLE WITH A TYPICAL 4 PANEL UNIT

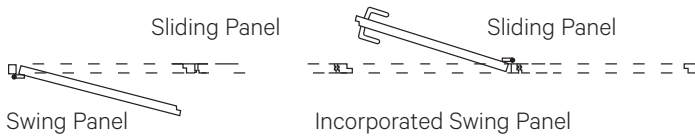
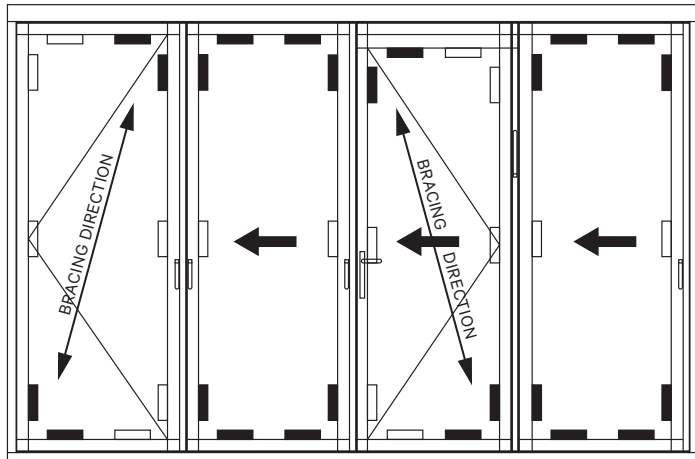

- Setting blocks for tension
- Setting blocks to keep distance

NanaWall Limited Warranty

NanaWall is pleased to provide the following warranty to the owner of NanaWall products, including the initial purchaser and all subsequent owners (“Owner”), subject to all terms and conditions stated herein. This Warranty supersedes all previous product warranties and is the exclusive statement of all commitments and rights of NanaWall with respect to its products sold on or after May 1, 2023, to be installed in the United States (excluding territories) or Canada.

NanaWall shall have no obligation to respond under this Warranty until receipt of proper notice of a claim and an opportunity to respond. Upon notice and confirmation by NanaWall of a condition covered under this Warranty, NanaWall will respond in good faith and in a timely manner as follows:

TEN YEAR COVERAGE.

For ten (10) years from the date of delivery by NanaWall (“Delivery”), NanaWall will respond as follows:

Insulated Glass. For an insulated glass unit with a permanent material obstruction of vision due to a premature failure of the glass seal, NanaWall will ship a replacement glass unit or panel.

Exception: insulated glass units for cero® are covered for five (5) years from Delivery.

Powder Coat or Baked-on Fluoropolymer Surface Finish of Aluminum Profiles. For powder coat or baked-on fluoropolymer surface finish not functioning as an Effective Surface Material (“ESM”*), NanaWall will, at its option, (1) assume reasonable costs to restore the finish using standard commercial refinishing techniques or (2) ship replacement parts. Uneven fading is not a covered condition due to environmental variables.

Exception: Products installed within two (2) miles of any coastal area or body of salt water or other harsh or corrosive environments or chemicals (“Harsh Environments”) are covered for one (1) year from Delivery, provided that the instructions in Specific Suggested Maintenance For Coastal Salt Water and Other Extreme Environments included in the Owner’s Manual for each Product and is available for review on NanaWall’s website, is properly implemented and documented.

**An ESM is a finish without (1) substantial cracking, chipping, or peeling due to the deterioration of the finish (exclusive of mechanical damage); (2) chalking in excess of a numerical rating of 8 as per ASTM D 659; or (3) fading or color changes in excess of 5 NBS units as per ASTM D 2244.*

Rollers. For a roller with material or workmanship issues that significantly impair proper operation and function, NanaWall will ship a replacement roller.

Wood and Other Remaining Components (for product installed by an independent NanaWall Certified Installer or Approved Installer*). For all remaining components of NanaWall products not otherwise addressed herein with a material or workmanship issue that substantially impairs operation and function, NanaWall will, at its option, (1) ship a replacement part or product or (2) ship any replacement part or replacement product in the same stage of fitting and/or finishing as originally supplied by NanaWall. This includes wood frame components, hinges, handles, locking mechanisms, tracks, beads, and weather-stripping.

FIVE YEAR COVERAGE.

For five (5) years from Delivery, NanaWall will respond as follows:

Laminated Glass. For a laminated glass unit with permanent material obstruction of vision due to premature delamination, NanaWall will ship a replacement glass unit or panel.

Wood and Other Remaining Components (for product NOT installed by an independent NanaWall Certified Installer or Approved Installer*). For all remaining components of NanaWall products not otherwise addressed herein with a material or workmanship issue that substantially impairs operation and function, NanaWall will ship a replacement part or product without charge in the same stage of fitting and/or finishing as originally supplied by NanaWall. This includes wood frame components, hinges, handles, locking mechanisms, tracks, and weather-stripping.

THREE YEAR COVERAGE.

For three (3) years from Delivery, NanaWall will respond as follows:

Anodized Surface Finish of Aluminum Profiles. For anodized surface finish of aluminum profile not functioning as an ESM,* NanaWall will, at its option, (1) assume reasonable costs to restore the finish on a non-compliant (non-ESM) material using standard commercial refinishing techniques or (2) ship replacement parts.

Exception: Products installed in Harsh Environments are not covered.

ONE YEAR COVERAGE.

For one (1) year from Delivery, NanaWall will respond as follows:

Screens. For a screen part (excluding the screen mesh) with a material or workmanship issue that substantially impairs the function of the screen, NanaWall will, at its option, (1) ship a replacement screen or (2) upon return by owner, repair the screen without charge.

ADDITIONAL SERVICE INFORMATION

This Warranty does not cover labor costs to remove existing parts or products, install a replacement part or product, costs to finish wood products, or the cost to repair or replace surrounding substrates, trim, or other work. Nor does it cover costs incurred due to delays or other construction costs, costs for late or damaged delivery, loss of revenue, loss of time, liquidated damages, inconvenience, or loss of use of the product or any parts or components. NanaWall reserves the right to determine whether or not a covered condition exists. If the claim is not covered under this Warranty, NanaWall may charge and collect a fee for on-site product inspections.

Any replacement part or product will be shipped to the location of original product delivery by NanaWall. Replacement products will be the closest equivalent current product and may not be an exact match to the original. Any replacement parts or any repairs are warranted for the remainder of the original limited warranty period. If providing a replacement part or product is not commercially practicable, NanaWall may elect to refund the purchase price of the affected product in full satisfaction of its obligations.

Wood. Wood components must be properly finished on all sides promptly after receipt of unit, before installation, and prior to exposure to weather. Repair or replacement of a warped wood panel or frame can be delayed by up to 12 months from date of claim to allow the wood component to adjust to local environmental conditions.

Glass. Unloading the replacement glass/panel from the delivery truck is the responsibility of the owner. Due to the weight of the product, appropriate manpower and/or equipment will be needed to unload and move the glass/panel to the location for replacement. Depending on the size of the replacement part and interior building dimensions, it may not be possible to transport the glass/panel through the interior of the building. NanaWall is not responsible for any costs associated with moving the replacement glass/panel at the delivery location.

**Whether an installer is a NanaWall Certified Installer or Approved Installer is determined by the installer's status as of the date of delivery. NanaWall maintains information regarding the installers designated as Certified Installers or Approved Installers.*

NOTICE PROCESS

Written notice of any claim under this Warranty with supporting documents such as photos or videos must be given to Nana Wall Systems, Inc. via email to service@nanawall.com or via mail to 100 Meadowcreek Drive, Corte Madera, CA 94925, promptly when discovered. A condition will not be covered under this Warranty if there is a failure to notify NanaWall in writing (1) within 7 days of receipt of the product for any defect which an ordinary inspection would reveal, (2) within a reasonable time during the warranty period after an impairment in operation and use is manifest or a hidden defect is discovered, or (3) for claims first made after expiration of the coverage period outlined in this Warranty.

DISCLAIMERS & LIMITATIONS

Any responsibility of NanaWall is contingent upon owner fulfilling its notice obligations as stated in this Warranty. The owner shall have no standing to assert a claim absent timely notice to NanaWall and an opportunity to cure. The remedies prescribed in this Warranty are the exclusive and sole remedies available to the owner who hereby waives any claim not encompassed herein. This exclusivity and waiver survive expiration of warranty coverages herein. In no event shall the liability of NanaWall or any seller of NanaWall product exceed the price paid for the product.

This Warranty is the sole and exclusive warranty for NanaWall products. **ALL OTHER WARRANTIES, EXPRESS OR IMPLIED, INCLUDING ANY WARRANTY OF MERCHANTABILITY OR FITNESS FOR A PARTICULAR PURPOSE, ARE DISCLAIMED. NANAWALL SHALL NOT BE LIABLE FOR CONSEQUENTIAL OR INCIDENTAL DAMAGES.** Some state and federal laws may not allow disclaimers of implied warranties or exclusions of incidental or consequential damages, so these limitations or exclusions may not apply to you. Where federal law prohibits disclaimer of implied warranties, the duration of any implied warranty is limited to the duration of the relevant coverage period, if less than the statutory limitation period. This Warranty gives you specific legal rights, and you may also have other rights which vary from state to state.

This Warranty may only be modified by a writing signed by an officer of NanaWall. Any action taken by NanaWall does not create a new warranty or extend the duration of the original product warranty. A failure by NanaWall to enforce a warranty provision shall not constitute a waiver barring subsequent enforcement.

EXCLUDED CONDITIONS.

This Warranty does not cover the following conditions, or any damage or issues caused in whole or part by the following:

- Improper product selection, application, storage, handling, modification, or waterproofing; Movement of surrounding substrates, including deflection of the header of more than ¼", or any other stresses on product; Improper installation, flashing, or integration into the structure; Failure to provide an adequate overhang; Failure to prevent the effects of sheeting rain or water; Failure to install proper weep holes in sill where needed, and failure to properly drain water exiting weep holes in the sill; Failure to meet code or specification requirements.
- Finishing by anyone other than NanaWall, including, but not limited to, not properly finishing all sides of wood products promptly after receipt of unit, before installation, and before exposure to weather, finishing exterior wood in dark colors, or not refinishing periodically; Discoloration of finish; Failure to immediately repair any breaches such as scratches, chips, or abrasions in any finish or aluminum profile.
- Condensation, frost, or mold caused by high interior relative humidity; Installation near swimming pools, saunas, hot tubs or other high humidity environments or sources of chlorine; Harsh chemicals such as road salt, solvents, acid, brick or mortar wash, or cleaning chemicals; Corrosion, oxidation, discoloration or tarnish on product installed in Harsh Environments.
- Normal weathering, wear and tear; Failure to follow the NanaWall operation and maintenance instructions; Failure to operate the product for more than one month; Failure to clean and maintain aluminum surfaces in accordance with AAMA 609 and 610 or not maintaining adequate cleaning records.
- Imperfections in glass that do not affect the product's structural integrity or obscure vision and cannot be detected from within 10 feet as per ASTM C 1036; Accidental or spontaneous glass breakage; Glass breakage due to thermal or other stresses, or glass with film or other coatings applied to the surface; Industry accepted bow, warp or distortion in glass and minor variations in glass color; Glass not installed as per NanaWall's instructions.

- Variations in wood grain or color; Warp within the allowable warp tolerance for wood panels per ANSI/WDMA I.S. 6-A-01; Warp that does not affect the normal functioning of the Product; Warpage on wood panels caused by leaving panels in the open position exposed to the elements or not engaging the locking points properly when in the closed position; Resin or sap bleeding from wood panels.
- Panel shrinkage or expansion caused by change in weather; Expansion or bowing of aluminum units caused by exposure to sunlight or caused by temperature difference between interior and exterior panel surfaces.
- Acts of God, falling objects, fire, accidents, external forces, extreme weather events, or other conditions beyond NanaWall's control.
- Gas fill or retention levels in insulated glass units.
- Field testing of Product; Performance of the Product in conformance to any published NanaWall testing results (e.g. air infiltration, water infiltration, structural loading, thermal and sound). Published test results measure the laboratory performance of a single sample of the product of a certain size, sill and configuration that may not be applicable to the Product being field tested. Performance during testing may vary depending upon handling, installation, use, maintenance, and time after installation. Field testing must be in compliance with AAMA 502, including water penetration testing at 2/3 of the pressure of applicable published test results.
- Products or components not supplied by NanaWall; Products that have not been paid for in full; Products ordered in larger sizes or special configurations beyond NanaWall's published specifications. Product with glass that is heavier than NanaWall specifications; Product that has been modified or altered in any manner.

NanaWall Warranty Registration

Must be filled out and returned to Nana Wall Systems, Inc., 100 Meadowcreek Drive, Corte Madera, CA 94925 within 30 days from date of purchase of the NanaWall in order for the limited warranty to become effective.

NANAWALL ORDER # _____

PROJECT NAME _____

Date of Purchase _____

Purchaser Name _____

PROPERTY OWNER

Name _____

Address _____

Telephone _____

E-mail _____

Project Address (if different from above) _____

INSTALLATION

Installer Name _____

Address _____

Telephone _____

E-mail _____

Type of project new residential restaurant shopping mall
 residential remodel office building other _____

Architect Name _____

Address _____

1. Is the installation complete? yes If yes, date completed _____

no If no, date scheduled _____

2. Have you been shown how to yes Is operation satisfying? yes no

operate your new NanaWall? no If no, why not? _____

Print Name _____

Signature _____

Date _____



Nana Wall Systems, Inc.
100 Meadowcreek Drive #250
Corte Madera, CA 94925

800 873 5673
415 383 3148
Fax 415 383 0312

info@nanawall.com
nanawall.com
©2023 Nana Wall Systems, Inc.